

Spherical roller bearings, cylindrical and tapered bore

Principal dimensions			Basic load ratings		Speed ratings		Designation
d	D	B	dynamic C	static C0	Reference speed	Limiting speed	
mm			kN		r/min		* SKF Explorer bearing
140	210	53	485	680	2600	3400	- 23028 CCK/W33 *

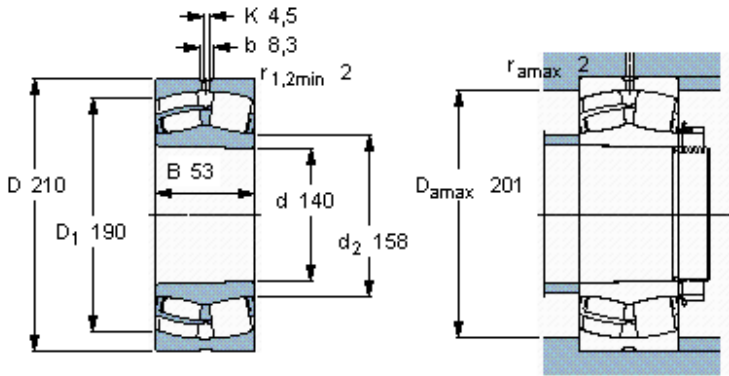

Tapered bore, taper
1: 12

Calculation factors

- e 0,22
- Y_1 3
- Y_2 4,6
- Y_0 2,8